

## **ULYDOR BY KALIKA** (PBX Door Entry Systems)



### **Operating Instructions**

Thank you for purchasing our Ulydor PBX Modular Door Entry System. Ulydor is a highly versatile door entry system, allowing units from 0-64 buttons to be built.

When a visitor arrives at the building it allows them to select from the name panel the company/person they wish to visit. The visitor presses the button for that company/person and the appropriate telephone then rings and allows a conversation to take place. To allow the visitor access the company/person presses a two digit code on the handset, activating the door lock and enabling entry to the building.

Ulydor works with most telephone systems able to provide a two wire analogue extension. With every installation a Ulydor Control Unit will be required of which there are three options: a UC0 (No Buttons), UC1 (One Button) and a UC2 (Two Buttons). By adding C4 (4 button extension control module) and M4 (4 button slave module) units, a system of 0-64 buttons can be built. Each button can be programmed with up to a 16 digit number, including \*, #, pause and hook flash.

Examples of Ulydor Entry Systems			
Buttons	Modules	No. of Modules	MK-x
0	UC0	1	1
1	UC1	1	1
2	UC2	1	1
4	UC0 - C4	2	2
5	UC1 - C4	2	2
6	UC2 - C4	2	2
8	UC0 - C4 - M4	3	3
9	UC1 - C4 - M4	3	3
10	UC2 - C4 - M4	3	3
12	UC0 - 2 x C4 - M4	4	4
13	UC1 - 2 x C4 - M4	4	4
14	UC2 - 2 x C4 - M4	4	4
16	UC0 - 2 x (C4+M4)	5	3 + 2
17	UC1 - 2 x (C4+M4)	5	3 + 2
18	UC2 - 2 x (C4+M4)	5	3 + 2
20	UC0 - 3 x C4 - 2 x M4	6	3 + 3
21	UC1 - 3 x C4 - 2 x M4	6	3 + 3
22	UC2 - 3 x C4 - 2 x M4	6	3 + 3
24	UC0 - 3 x C4 - 3 x M4	7	4 + 3
25	UC1 - 3 x C4 - 3 x M4	7	4 + 3
26	UC2 - 3 x C4 - 3 x M4	7	4 + 3
28	UC0 - 4 x C4 - 3 x M4	8	4 + 4
29	UC1 - 4 x C4 - 3 x M4	8	4 + 4
30	UC2 - 4 x C4 - 3 x M4	8	4 + 4
64	UC0 - 8 x C4 - 8 x M4	17	4 + 4 + 4 + 4 + 1

**Keypad can only be added on systems between 0 – 18 buttons.**

**Camera module can be added on any combination of buttons.**

The Ulydor Control Modules can also be used in conjunction with a UCK (12 Button Keypad Module) – particularly useful for staff entry.

Ulydor is supplied with 2 relays allowing the control of two doors for opening and closing as well as lighting, cameras, etc.

The programming of a Ulydor Door Entry System is carried out by the use of Windows based software supplied with all UC modules, or by the use of the telephone keypad. It can also be carried out remotely and those with the system code can program or re-program remotely by use of a GSM mobile telephone or by connecting a jumper on the PCB. If a password is forgotten, then re-programming would be carried out by use of the jumper.

# TABLE OF CONTENTS

1	BASIC DESCRIPTION .....	6
1.1	Features .....	6
1.2	Module Assembly .....	7
2	INSTALLATION OF ULYDOR ASSEMBLY .....	9
2.1	Installation of Surface Mount Module .....	9
2.2	Flush-Mounted Installation .....	9
2.3	Change of Nameplates .....	10
2.4	Installing the Modules .....	11
2.4.1	UCx Basic Module .....	11
2.4.2	Extending Modules - C4 & M4 .....	13
2.4.3	UCK – 12 Button Keypad Module .....	14
2.4.4	Signalling Overview .....	15
3	USING ULYDOR .....	16
3.1	Ulydor System Without & With Keypad .....	16
3.1.1	Without Keypad .....	16
3.1.2	With Keypad .....	17
3.2	Using the System .....	18
3.2.1	Outgoing Call .....	18
3.2.2	Incoming Call .....	18
4	PROGRAMMING OF PARAMETERS .....	19
4.1	Programming through Phone .....	19
4.1.1	Entry to Programming .....	19
4.1.2	Programming of Parameters .....	19
4.2	Programming from PC – Program Nset .....	20
4.3	Overview of Parameters .....	21
4.4	Description of Parameters .....	22
4.4.1	Direct Dialling – Memories .....	22
4.4.2	Relays .....	23
4.4.3	Basic Parameters .....	25
4.4.4	Time Parameters .....	27
4.4.5	Presetting and Deleting .....	29
4.4.6	Programming Termination .....	29
4.5	System Setting .....	29
4.6	List of Presetting Parameters .....	30
5	TECHNICAL PARAMETERS .....	31
5.1	Electrical Parameters .....	31
5.2	Mechanical Dimensions .....	31
6	TABLE OF EASY PROGRAMMING .....	32

## TABLE OF CONTENTS (Contd)

7	DISTY 300 .....	34
	7.1 Description .....	34
	7.2 Signalling .....	34
	7.2.1 LED Indication .....	34
	7.2.2 Tones .....	35
8	IP CAMERA .....	37

# 1 BASIC DESCRIPTION

---

## 1.1 Features

- Modular system allows connection of 0 - 64 buttons.
- Voice link is supplied from telephone extension.
- Pulse and Tone dialling (DTMF).
- Two 16 digit numbers with each button (including ρ, #, Hook Flash / Recall and Pause).
- Day / Night switching.
- Extend call time by ρ or #
- Connection of two independent locks or activate other devices.
- 5 switching modes (e.g. camera, lighting, gradual opening, etc).
- Two codes for hanging up the Ulydor from the telephone.
- Two codes for door opening from the telephone.
- Six code locks (password from buttons at the door).
- Optional keypad, on systems with between 0-18 standard buttons.
- Keypad modes can be for direct dialling or memory dialing.
- Optional maximum number of rings to answer an incoming call.
- Optional time interval between button pressing for code entry.
- Optional time for hanging up before redial.
- Optional time before alternative number call.
- Optional parameters for tone choice, length of Recall and Pause.
- Default setting of some parameters.
- Besides the Preset Basic setting it is possible to preset two alternative default settings.
- Remote telephone programming using DTMF tones or direct from a PC.
- Integrated heating of printed circuit
- Permanent lighting buttons and name cards.
- Earth connection for better protection against static electricity.

## 1.2 Module Assembly

The structural elements of Ulydor are the basic modules: UC0, UC1, UC2 and extending button modules C4 and M4 with four buttons.



UC0 Module



UC1 Module



UC2 Module



C4/M4 Module

It is possible to provide the assembly with numerical keypad and camera module (IP, WI-FI, Coax).



UCK Module



IP Camera



Analogue Camera



DECT Disty Box

The complete assembly consists of a system of maximum 4 modules in column and maximum 3 columns side by side. Examples of frame configuration are:

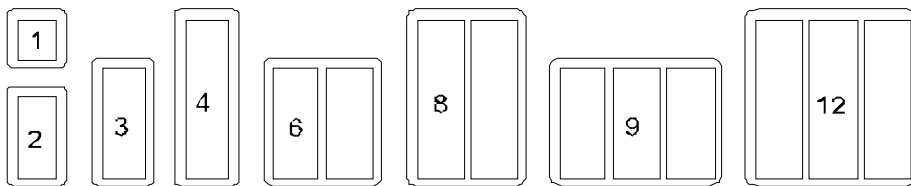



**SMB1**  
Protected Cabinet &  
Cosmetic Surround



**SMB2**  
Protected Cabinet &  
Cosmetic Surround



**SMB4**  
Protected Cabinet &  
Cosmetic Surround



**FMBB2**  
Flush Mount Back Box  
Cosmetic Surround



**UC2 + C4 + FMBB2 (Horiz)**



## 2 INSTALLATION OF ULYDOR ASSEMBLY

---

### 2.1 Installation of Surface Mount Module

The installation of a SMBx Surface Mount Box is made by screwing the assembly to the wall.



### 2.2 Flush-Mounted Installation

The FMBBx box is mounted into the wall and secured by the fixing screws provided. Lugs are provided for joining FMBBx boxes together if larger installations are required.

The cosmetic protecting frame provides an overlap to aid any unevenness when mounting the box into the space created in the wall. The canopy (EWHx) is necessary for installations in external areas and is an accessory for the FMBBx box and replaces the need for the FMBBx cosmetic surround. When installed in exposed areas that are subject to condensation, temperature changes, waterspray, or rain it is recommended that the EWHx box is used and that the heater connector is jumpered onto the UCx module and set to the "ON" position.



The **BOARD HEATING** has two positive functions. Firstly, it heats up the electronics in winter at temperatures  $-20^{\circ}\text{C}$  (temperature range has guaranteed parameters from  $-20^{\circ}\text{C}$ ), and secondly with external installations experiencing rapid temperature changes in humid areas the heater prevents condensation on the Ulydor UCx PCB.



### 2.3 Change of Nameplates

The first step is to dismantle the fixing frame (See Diagram 1) by removing the two hidden screws top and bottom. Remove the modules requiring information change by inserting a screw driver into the side of the module (See Diagrams 2 and 3). Each module is in two parts, the front facia plate being metal and the back plate being plastic. Separate the two parts and note that each button has its own nameplate located under a clear plastic flag (See Diagram 4). New information can be printed from the Nset program on the supplied CD or downloaded from [www.kalika.co.uk](http://www.kalika.co.uk)

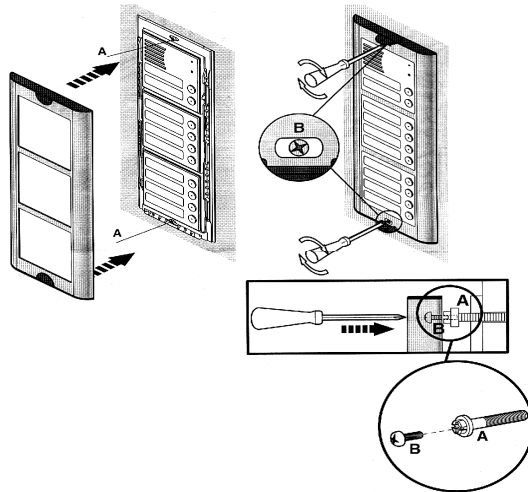

Diagram 1

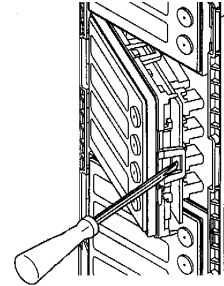

Diagram 2



Diagram 3

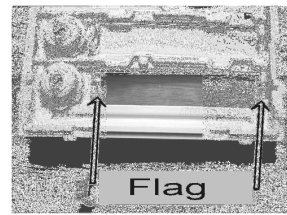

Diagram 4

## 2.4 Installing the Modules

### 2.4.1 UCx Basic Module

The Ulydor basic module is supplied in three variants:

- UC0 - No Buttons
- UC1 - One Button, and
- UC2 - Two Buttons

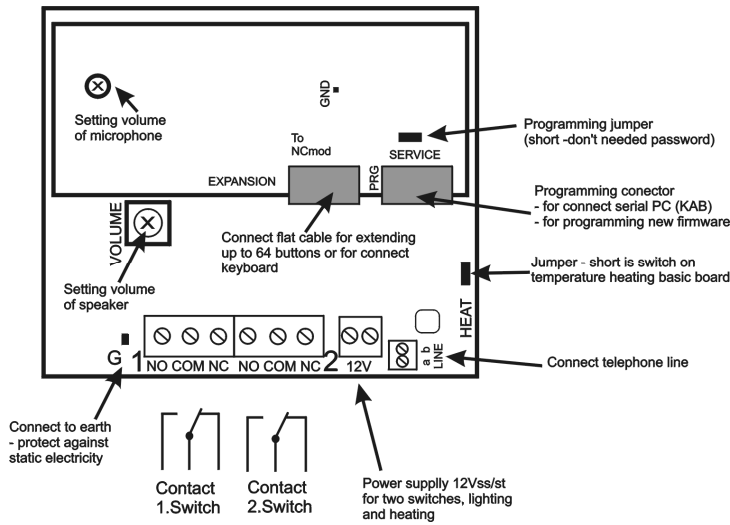
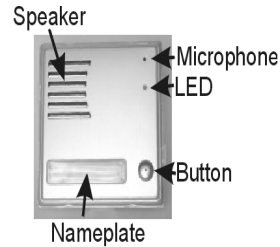
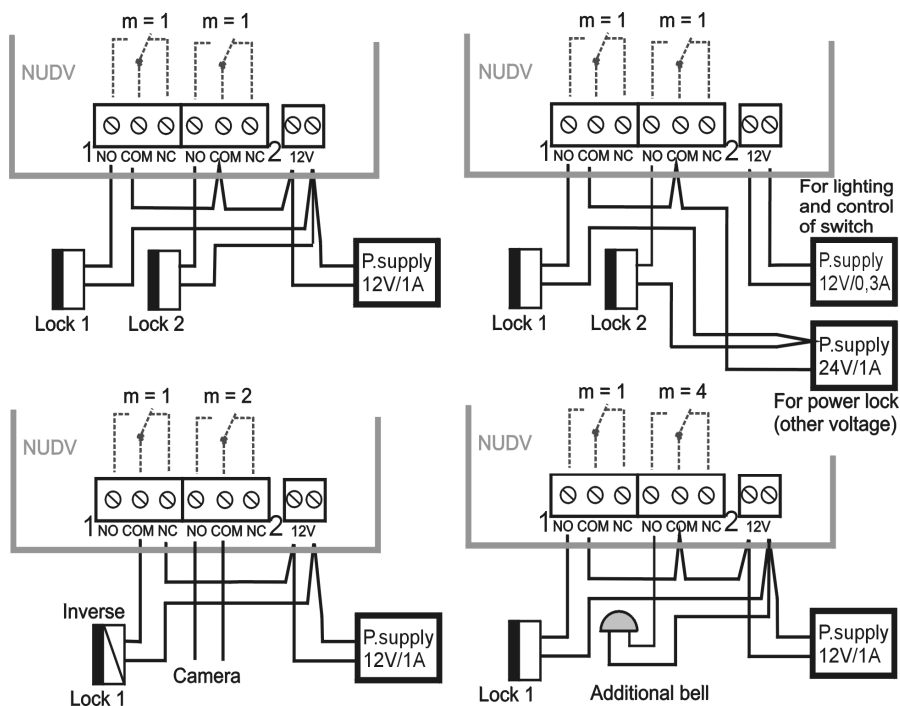

**Figure 1 - Rear view of Basic Module**

The telephone extension circuit from the PBX / line should be connected to the terminal marked "ab line" (See Figure 1). The Ulydor circuits are powered from the telephone line and nothing extra should be required to make voice communication.

If one or two relays are to be used, an AC PSU of between 10V – 15V, or with DC PSU between 12V – 18V must be connected to the "12V" terminal. The PSU loading depends on number of modules, since it feeds backlighting to the name card display. With the maximum number of modules the demand will not exceed 300mA. If the PSU is also used for power feed to the lock(s), then consideration needs to be given to the electrical demands of the lock(s). In practice a 12V/1A meets these demands.

The connection of relay contact terminals is shown in Figure 1. The "NO" designation means a normally open relay contact, "COM" means a pin contact (middle) and "NC" means a normally closed contact. The contacts of both relays are galvanically isolated from each other and from other Ulydor circuits. The connection variations are shown in Figure 2.



**Figure 2 - Examples of Switch Connections**

The "G" Faston 2.8mm terminal protects against static electricity (to be connected to earth).

The "**VOLUME**" trimmer allows adjustment to the volume of the loudspeaker, it has no effect on other Ulydor features. The "**MIC**" trimmer (placed under PDV board) provides the adjustment of microphone volume. Such adjustment can improve the quality of speech when subjected to ambient noise in the street, etc.

The "**HEAT**" jumper allows the switching of board heating. This function requires the connection of 12V supply on "**12V**" marked terminal.

The "**EXPANSION**" marked connector serves the connection of extending modules by means of flat cable.

The "**PRG**" marked connector provides the Ulydor adjustment from the PC by means of serial cable and allows service programming and new software uploads.

The "**SERVICE**" jumper allows direct access to programming. It can be used in the absence of password for programming.

## 2.4.2 Extending Modules – C4 & M4

These modules are supplied in two designs.

The **C4** module has four buttons and includes the electronics to connect to a UCx module. The C4 is connected to a UCx by a flat cable for additional buttons and lighting. The flat cable connector block is designed for one way connection to prevent incorrect alignment and therefore keeps the connection routing correct.

The **M4** (slave) module has four buttons which connect via terminal blocks on the previous C4 module. The connections are individually wired by screw terminals (See Figure 3).

**Remember:**

Ulydor C modules always connect in series, using the flat cable connectors to the main control unit (UCx). A module always connects to a C4 module.

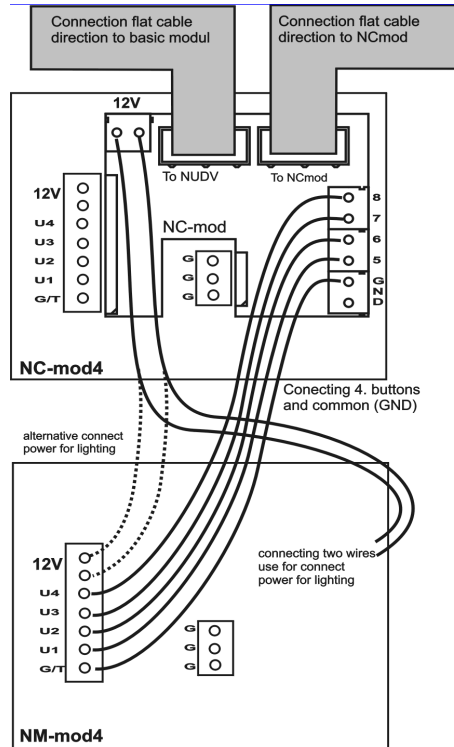

**Figure 3 – Connection of C4 & M4**

### 2.4.3 UCK – 12 Button Keypad Module

The keypad module is connected by flat cables to the UCx or the C4 module. The keypad module is always the last module in the row (no other module can be connected beyond it). It can only be linked to the control module, or the first/second C4 modules. This means that systems with a keypad support a maximum of 18 direct dial buttons. The possible assemblies of modules are:



- UCx + UCK (Position 1)
- UCx + C4 + UCK (Position 2) + M4 (if required)
- UCx + C4 + C4 + UCK Position 3) + 2 x M4 (if required)

**Note:** when programming the position of keypad connection must be correctly specified (parameter **48**).

The extension or memory choice is entered by pressing the numeric buttons. The key symbol must be pressed first before entering a password. When pressing **X**, the Ulydor will hang up.

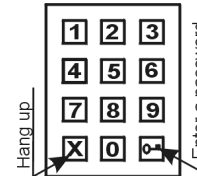













### 2.4.3 Other Modules

Other extending modules are offered and can be ordered through your supplier.

## 2.4.4 Signalling Overview

Ulydor signals acoustic tones during its operation. There is a further signal provided by an LED placed on the main control unit.

Condition	Tones	Tone frequency	LED
Line lifting up		425-850-1275	glows
Line hanging up		1275-850-425	goes out
Report after calling		425-850-1275	glows
Command confirmation from phone		425	
Dialling	DTMF/Pulse		goes out
Call			glows
Notice about call end		1275	glows
Entry to programming from phone		850	glows
Programming from phone		mod. 850	glows
Parameter confirmation			glows
Entry to programming from PC		850	glows
Programming from PC			blinks
Connection to line (Reset)		1275-850-1275	blinks
Error (anything if unsuitable)		425....	
Empty memory (no programming number)		850-1275-1700.	

## 3 USING ULYDOR

---

Ulydor functions are influenced partly by the modules used (with or without keypad module) and partly by the Ulydor system parameters. For instance, if a single button module is installed the functions relate purely to that particular module's parameters. As another example, if a keypad is added the parameters of the keypad settings will affect some parameters of programming the main control unit.

### 3.1 Ulydor System Without & With Keypad

#### 3.1.1 Without Keypad

The system **buttons** are provided by the side of the nameplates for company/person extension inside the building. The visitor will press the corresponding button, the Ulydor System will open up the line either immediately, or with delay (**parameter 53**) and after the period given by **parameter 55** will dial the programmed phone number. The dialling number differs by choice mode, which is set in the Ulydor System (**parameter 47**):

- **Day / Night** mode – when the Ulydor System is set in Day mode, it is always dialling a number set in **parameter 1**. When in Night mode, it is always dialling a number set in **parameter 2**. The mode switchover is set in **parameters 45, 46**.
- mode of second number group = first press – it always dials a number set in **parameter 1**. By repeated pressing of the same button or detection of a busy tone after dialling the Ulydor System it will select the number from the second group (**parameter 2**). The next press of the same button again selects a number of the first group, etc.

If a visitor presses the button after the Ulydor System has already provided a line, the system will hang up for a given period (**parameter 54**), at the end of that period it will then reopen and dial a new number. The number choice is carried out in tone (DTMF), and pulse dialling according to the setting of **parameter 41**. Almost in all cases in the UK it will require DTMF.



The relay (**code lock**) can be controlled by the first 10 buttons of Ulydor. If the visitor presses buttons in a combination that meets the pre-programmed code (**parameters 32-34**) and the time among presses is not bigger than the set point (**parameter 53**), then the Ulydor will activate and deactivate the corresponding relay (if set in m=1 or m=5 modes) to the period given by **parameter 36 event. 38**. Then it will hang up the line.

### 3.1.2 With Keypad

The Ulydor System with keypad can also include (besides the keypad) up to 10 buttons of direct dialling always behaving as mentioned in Chapter 3.1.1, except the code lock as this is always situated on the keypad. After the keypad is connected, the position of where the keypad is connected should be set (**parameter 48**).

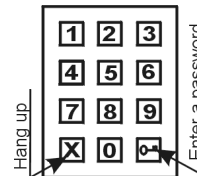

The keypad has two functional buttons:

- key symbol** = pressing the numerical combination is considered as the combination for control of the relays.
- X symbol** = when pressing **X** the Ulydor immediately will hang up.

The number selection on the keypad can be executed in two ways (**parameter 49**):

- The incoming person dialling a number (extension) as would be done on a phone – the period among button presses should be lower than the value given by **parameter 53**. After this period the Ulydor System will lift up and dial the given number.
- On memory mode the incoming person is dialling a two-digit number relative to the preset buttons (from 01-64), which represents the memory number, where the 16-digit number is stored (same as for buttons). The number dialling is managed by Day / Night setting or mode for two groups of numbers (as described in Chapter 3.1.1).

## 3.2 Using the System

### 3.2.1 Outgoing Call

An outgoing call is a call from the Ulydor (made by the visitor) to an internal user's telephone. After the visitor presses a button, the door entry system calls the internal telephone, which when answered, will allow voice connection to the visitor at the door. Using the telephone keypad, the internal user can then activate the relays (**parameter 35**), change over the Day / Night modes (**parameters 45, 46**) and hang up (**parameter 43**). 10 seconds before the call ends (**parameter 52**) the Ulydor will send a noticeable tone, signalling the call is about to end. However, the call may be extended by pressing the \* key (**parameter 42**). When the user ends the call the PBX sends a busy tone to the Ulydor and the Ulydor also hangs up.

### 3.2.2 Incoming Call

An incoming call is a call from an internal user's telephone to the Ulydor. After the extension number of the Ulydor is dialled, the Ulydor will ring and after a set number of rings (**parameter 51**) will answer whereupon it is possible to speak. The possibilities are the same as with an outgoing call (Chapter 3.2.1).

- During the first 10 seconds, # followed by the service password (**parameter 44**) can be entered. The Ulydor will then enter programming mode.
- The other exception of an incoming call is by connecting the "SERVICE" jumper. The Ulydor will automatically enter programming mode when answering an incoming call. This facility should be used if you have forgotten the service password. **Warning:** Never leave a system installed with the "SERVICE" jumper connected.

## 4 PROGRAMMING OF PARAMETERS

---

### 4.1 Programming through Phone

#### 4.1.1 Entry to Programming

The Ulydor System can be set to programming mode in two ways:

1. **by password** – Dial the extension number of the Ulydor and the Ulydor will answer. Within the first 20 seconds you should dial #xxxx (where xxxx is the programming password). If correct, the registration tone to programming will sound and afterwards the programming tone can be heard.
2. **by "SERVICE" jumper** – dial the extension number of the Ulydor and the Ulydor will answer in programming mode – you hear tone for answering, registration tone to programming and afterwards the programming tone can be heard. You should only use the **"SERVICE" jumper** if you have forgotten the password!

#### 4.1.2 Programming of Parameters

The initial state for programming is signalled by the programming tone and the Ulydor will return to this state after 5 seconds with no DTMF input (even if you have started programming).

There are two types of parameter:

**fixed length** – the majority of parameters are of fixed length. After entering the parameter you will hear an acknowledge tone.

**variable length** – some of the parameters are of a variable length. A good example is the parameters which store the numbers dialled when a user presses a button. After entering the parameter you should wait 5 seconds until you hear the confirmation tone.

If during programming you enter an invalid digit the Ulydor will immediately emit an **error tone**. The parameter will not be recorded nor changed, the Ulydor will return to programming mode and it is possible to repeat the parameter setting or program another parameter.

The Ulydor stays inactive in programming mode for 34 seconds then it will automatically hang up. You can also end the programming mode by pressing 9.

**Note 1:** if you wish to keep the connection (extend beyond the 34 second period), press 6, 7, 0, \* or # from time to time. The Ulydor immediately responds by error tone and will extend the period before hanging up.

**Note 2:** When entering the door release passwords (parameters 32, 33, 34), you can finish with the # key. This will save you waiting 5 seconds for the confirmation tone.

## 4.2 Programming from PC – Program Nset

The Ulydor can be set up from a PC. The special RS232 PROG cable should be connected to a serial port and the Nset program should be installed. The Ulydor has to be connected to a telephone line.

### Procedure:

- Connect the Ulydor to the telephone line
- Connect the Ulydor to the PC via the programming cable (if there is no serial port on your PC use a SUB – RS232 adapter). The Ulydor will answer and the LED light on the front panel will light.
- Run the Nset program – the Ulydor will report entry to PC programming mode. While the Nset software program is being used the Ulydor will be in programming mode – this status is indicated by a flashing LED (1 second on 1 second off) on the front of the UC module. If the connection to the Nset software is lost it will be necessary to disconnect and reconnect the RS232 programming cable. The Ulydor UC module will answer and will indicate re-entry to programming mode.

### 4.3 Overview of Parameters

Param.	Value	Meaning	Basic	Exam.1	Exam.2
1	tt nn...	Number <b>nn</b> under button <b>tt</b>	-	-	-
2	tt nn...	Number <b>nn</b> under button <b>tt</b>	-	-	-
31	r m	replay <b>r</b> works in <b>m</b> mode	11 21	11 22	11 25
32	r hhhhhh	Password <b>hhhhhh</b> for <b>r</b> relay in <b>Day + Night</b> mode	-	1 121 2 122	1 4561 2 4562
33	r hhhhhh	Password <b>hhhhhh</b> for <b>r</b> in <b>Day</b> mode	-	-	-
34	r hhhhhh	Password <b>hhhhhh</b> for <b>r</b> in <b>Night</b> mode	-	-	-
35	r aa	Command <b>aa</b> from phone after <b>r</b> relay closing	155 266	155 266	155 266
36	r ss	<b>ss</b> period [sec] of <b>r</b> relay closing	105 205	102 202	105 205
37	r p	<b>r</b> relay control by incoming call	11 21	11 21	11 21
38	Xx	<b>xx</b> period [sec] between relays 1 & 2 closing	10	10	15
41	V	Choice type <b>v</b> – tone / pulse	0	0	0
42	Z	Sign for call extension	*	*	*
43	g bb	Command for Ulydor hanging up from phone	155 266	155 244	155 244
44	Xxxx	Service password	0000	0000	0000
45	Dd	Command for <b>Day</b> switching	11	11	11
46	Nn	Command for <b>Night</b> switching	10	10	10
47	E	Mode of Ulydor choice	0	1	0
48	C	Keypad connection	0	0	1
49	O	Keypad mode	0	1	0
51	Q	Number of rings before Ulydor call lifting up	2	1	2
52	D	Maximum call time	2	2	1
53	W	Time among button presses	2	2	2
54	Z	Time of hanging up when dialing repeated	2	2	2
55	Z	Time before dialling	1	1	1
56	H	Number of rings before hanging up	12	12	12
57	T	DTMF tone duration (tone) choice	5 (100ms)	5 (100ms)	5 (100ms)
58	M	Gap duration among DTMF tones	5 (100ms)	5 (100ms)	5 (100ms)
59	F	Flash duration	1 (100ms)	1 (100ms)	1 (100ms)
50	P	Pause duration / interdigit gap	8 (800ms)	8 (800ms)	8 (800ms)
8#	#	Basic setting	executes		
8#	1	Setting per example 1		executes	
8#	2	Setting per example 2			executes
81		Deletes all numbers in group 1 ( <b>Day</b> )			
82		Deletes all numbers in group 2 ( <b>Night</b> )			
83		Basic setting only for parameters 3x	only 3..		
84		Basic setting only for parameters 4x	only 4..		
85		Basic setting only for parameters 5x	only 5..		
9		E N D			

## 4.4 Description of Parameters

### 4.4.1 Direct Dialling – Memories

#### Group 1 – Day Mode

Param.	Value	Meaning	Basic	Exam.1	Exam.2
1	tt nn...	No. nn under button tt	-	-	-

**tt** – button number (memory), always set in two-digit manner [01-64]

**nn** – telephone number up to 16 digits, we want to store. To store other choice flags the assignment given in the table is used.

meaning	choice
0 - 9	0 - 9
#	#
*	**
Flash	* #
Pause	* 0

The numbers stored in parameter 1 are the number of the **first group** or numbers of **Day** mode. Neither the basic setting nor settings per examples change or delete the stored numbers.

#### Group 2 – Night Mode

Param.	Value	Meaning	Basic	Exam.1	Exam.2
2	tt nn...	No. nn under button tt	-	-	-

**tt** – button number (memory) is always set in two-digit manner [01-64]

**nn** – telephone number up to 16 digits that is to be stored. To store other choice flags the assignment given in the table is used.

meaning	choice
0 - 9	0 - 9
#	#
*	**
Flash	* #
Pause	* 0

The numbers stored in **parameter 2** are the numbers of the **second group** or numbers of **Night** mode. Neither the basic setting nor settings per the examples change or delete the stored numbers.

**Note:** The switchover to Day / Night mode remains set in the Ulydor System even after the line has been disconnected.

#### 4.4.2 Relays

Param.	Value	Meaning	Basic	Exam.1	Exam.2
31	R m	relay r works in m mode	11 21	11 22	11 25

r – relay number [1-2]

m – relay mode [for r=1 1-4 , for r=2 1-5]

**m=1 relay** mode – will activate on command or password for **ss** period (used for electrical locks, gate opening etc.)

**m=2 camera** mode – will activate when Ulydor goes off-hook and de-activates by hanging up.

**m=3 lighting** mode – will activate when Ulydor goes off-hook and stays activated for **ss** period after Ulydor line hangs up (the line is engaged for this period).

**m=4 switch** mode – will close after button pressing and open after **ss** period (used for e.g. external bell or horn connections).

**m=5 delay opening** mode – Only applies to relay 2. Relay 1 is automatically set to mode 1. Relay 1 is activated for **ss** period, then time **xx** is proceeding before switch 2 activated. Then relay 2 is activated for **ss** period and afterwards the Ulydor System hangs up.

**Note:** Only Relay 1 can be activated from the phone, Relay 2 can be separately activated from buttons by password.

#### Passwords

Param.	Value	Meaning	Basic	Exam.1	Exam.2
32	r hhhhhh	Password hhhhhh for relay r in <b>DAY + NIGHT</b> mode	-	1 121 2 122	1 4561 2 4562
33	r hhhhhh	Password hhhhhh for relay r in <b>DAY</b> mode	-	-	-
34	r hhhhhh	Password hhhhhh for relay r in <b>NIGHT</b> mode	-	-	-

r – relay number [1-2]

hhhhhh – password for relay closing from buttons or keypad [2 to 6 digits]

Total of 6 passwords, they are controlled by Day / Night; the combination is entered either by Ulydor System buttons (first 10 buttons) or from attached keypad (after pressing of key symbol). The relay closing influences the set relay **mode** and **Day / Night** switchover. By setting of choice mode of **2 number groups** the Ulydor System is permanently in **DAY** mode.

By password choice some rules have to be observed:

- Select passwords in a way that would make it difficult to find its combination out, e.g. from wear of certain buttons by frequent use.
- Select the first password button from frequentless button for direct dialling (- extends choice time) (- not valid for keypad).
- Pay attention to congruity of password numbers when one password includes other one, e.g. relay 1 has 1234 and relay 2 has 12345. Then after pressing button 4 only relay 1 is called, but password choice 234 for relay 2 can call both relays after pressing relay 4.

**Note:** The switchover to Day / Night mode remains set in Ulydor even after line disconnection.

#### Operating Relays from the Remote Phone

Param.	Value	Meaning	Basic	Exam.1	Exam.2
35	r aa	command aa from phone after r relay closing	155 266	155 266	155 266

r – relay number [1-2]

aa – command from phone after relay closing [2 digits]

The same command can be set for both relays and they are activated at the same time. The advantage is to set the same command both for relay closing and command to Ulydor hanging up (**parameter 43**) **aa=bb**.

#### Relay Operating Time

Param.	Value	Meaning	Basic	Exam.1	Exam.2
36	r ss	ss period [sec] of r relay closing	105 205	102 202	105 205

r – relay number [1-2]

ss – duration of relay closing [2 digits 01-99]

#### Relay Operation During Incoming Call

Param.	Value	Meaning	Basic	Exam.1	Exam.2
37	R p	r relay control by incoming call	11 21	11 21	11 21

r – relay number [1-2]

p – parameter:

**p=1** allowed, or

**p=0** prohibited to control the relay during an incoming call.

This function prohibits the control of relays during an incoming call.



### Duration Between Operation of Relays 1 & 2 (Mode 5 only)

Param.	Value	Meaning	Basic	Exam.1	Exam.2
38	xx	xx period [sec] between relays 1 & 2 closing	10	10	15

**xx** – time between operation of relays 1 and 2 by **m=5** mode setting (gradual opening) [2 digits 01-99]

### 4.4.3 Basic Parameters

Param.	Value	Meaning	Basic	Exam.1	Exam.2
41	v	choice type v – tone / pulse	0	0	0

**v** – choice type **v=0** is DTMF tone choice, **v=1** is pulse choice

Param.	Value	Meaning	Basic	Exam.1	Exam.2
42	z	sign for call extension	*	*	*

**z** – sign for call extension \* or # (10 sec before call end the Ulydor will send a notice, then the call may be extended)

Param.	Value	Meaning	Basic	Exam.1	Exam.2
43	g bb	command for Ulydor hanging up from phone	155 266	155 244	155 244

**g** – command order [1-2] (two commands in order to hang up the Ulydor using both relays)

**bb** – command for Ulydor hanging up from phone [2 digits]

It is recommended to set the same command both for relay operation and the command for Ulydor to hang up.

Param.	Value	Meaning	Basic	Exam.1	Exam.2
44	xxxx	service password	0000	0000	0000

**xxxx** – service password for entry to programming

Param.	Value	Meaning	Basic	Exam.1	Exam.2
45	dd	command for <b>DAY</b> switching	11	11	11
46	nn	command for <b>NIGHT</b> switching	10	10	10

**dd** – command for **DAY** mode switching [2 digits]

**nn** – command for **NIGHT** mode switching [2 digits]

**Note:** The switchover to Day / Night mode remains set in Ulydor even after line disconnection.

Param.	Value	Meaning	Basic	Exam.1	Exam.2
47	e	mode of Ulydor choice	1	1	0

**e** – mode of Ulydor choice:

**e = 0** selects numbers of the first and second groups,

**e = 1** selects number per **Day / Night** DES mode.

Param.	Value	Meaning	Basic	Exam.1	Exam.2
48	c	keypad connection	0	0	1

**c** – **c = 0** only NC-mode connected to the basic module

**c = 1** keypad connected on the first position

**c = 2** keypad connected on the second position

**c = 3** keypad connected to the third position

**ATTENTION !!** This parameter setting will sharply influence keypad function.

Param.	Value	Meaning	Basic	Exam.1	Exam.2
49	o	keypad mode	0	1	0

**o** – **o = 0** dialling as on normal telephone (the number of the person to be contacted should be pressed on the keypad).

**o = 1** only the 2-digit memory number (the stored number of the person to be called), is entered on the keypad (memory number and corresponds to button number with respect to Day / Night switchover).

**ATTENTION !!** This parameter setting will sharply influence keypad function.

#### 4.4.4 Time Parameters

Param.	Value	Meaning	Basic	Exam.1	Exam.2
51	q	Number of rings before Ulydor answers	2	1	2

**q** – Number of incoming call rings, the Ulydor System lifts up between rings, namely 2 seconds after detection **q** – times rings. The number can be set from 1 to 9.

Param.	Value	Meaning	Basic	Exam.1	Exam.2
52	d	maximum call time	2	2	1

**d** – maximum call time before the Ulydor hangs up. This time can be extended during a call by sign choice on the telephone (\* or #). Time setting is per the table.

mean.	choice
0 - 9	0 - 9
#	#
*	**
Flash	* #
Pause	* 0

Param.	Value	Meaning	Basic	Exam.1	Exam.2
53	w	time between button presses	2	2	2

**w** – maximum time [sec] between button presses [range 1-9]

- **normal buttons**
  - **relay closing** – if the time between the next two presses is bigger than **w** time, the code is not evaluated correctly.
  - **dialling** – if the button being pressed is the first password number for relay closing, then choice is delayed by this **w** time.
- **keypad**
  - **relay closing** – if time between the next two presses is bigger than **w** time, the code is not evaluated correctly.
  - **Dialling** - is the same as of a telephone: if length of time after the last pressed button is longer than **w** time then the dialling starts. If the number is incomplete it is necessary to hang up (**X** button) and the dialling will be repeated.
  - **dialling from memory:** if length of time following the first pressed button is longer than **w** time then the entry of memory number has to be repeated.

Param.	Value	Meaning	Basic	Exam.1	Exam.2
54	z	time of hanging up when dialling repeated	2	2	2

**z** – time [sec] for which the Ulydor will hang up before repeated dialling (button pressing during call or dialling, busy tone detection) [range 1-5]

Param.	Value	Meaning	Basic	Exam.1	Exam.2
55	z	time before dialling	1	1	1

**z** – time [sec] between the Ulydor going off-hook and dialling [range 1-5]. This time is different for each exchange but most central exchanges usually manage to process dialling up to 2 seconds after line lifting up.

Param.	Value	Meaning	Basic	Exam.1	Exam.2
56	h	No. of rings before hanging up	12	12	12

**h** – when dialling has been completed it calculates the number of KVT (ringing tones). If the number exceeds **h** value it will hang up [range 04-99]. The dialling is repeated when the dialling mode of 2 groups is set.

Param.	Value	Meaning	Basic	Exam.1	Exam.2
57	t	DTMF tone duration (tone) choice	5 (100ms)	5 (100ms)	5 (100ms)
58	m	gap duration among DTMF tones	5 (100ms)	5 (100ms)	5 (100ms)
59	f	Flash duration	1 (100ms)	1 (100ms)	1 (100ms)
50	p	pause duration / interdigit gap	8 (800ms)	8 (800ms)	8 (800ms)

**t** - DTMF tone duration is determined per formula:  
 $(\text{no. entered} + 5) \times 10 = \text{tone duration [ms]}$  [range 1-0 i.e. 60-150ms]

**m** - gap duration among DTMF tones is determined per formula:  
 $(\text{no. entered} + 5) \times 10 = \text{gap duration [ms]}$  [range 1-0 i.e. 60-150ms]

**f** - flash duration is determined per formula:  
 $\text{no. entered} \times 100 = \text{Flash duration [ms]}$  [range 1-6 i.e. 100-600ms]

**p** - pause duration is determined per formula:  
 $\text{no. entered} \times 100 = \text{pause duration [ms]}$  [range 5-0 i.e. 500-1000ms]  
 - **p** time is simultaneously the duration of interdigit gap at pulse dialling.

#### 4.4.5 Presetting and Deleting

Param.	Value	Meaning	Basic	Exam.1	Exam.2
8#	#	basic setting	executes		
8#	1	setting per exam. 1		executes	
8#	2	setting per exam. 2			Executes

This setting does not influence **1** and **2** (numbers stored in memory)

Param.	Value	Meaning	Basic	Exam.1	Exam.2
81		deletes all numbers in group 1 (Day Mode)			
82		deletes all numbers in group 2 (Night Mode)			
83		basic setting only for params. 3x	only 3..		
84		basic setting only for params. 4x	only 4..		
85		basic setting only for params. 5x	only 5..		

Parameters 81 and 82 will execute deleting of all numbers stored in memories for buttons. Parameters 83 – 85 will execute a selective basic setting only for parameters starting with 3.. – 5..

**ATTENTION !!!** Deleting is non-reversible!!! **It will be necessary to reprogram if deleted.**

#### 4.4.6 Programming Termination

Param.	Value	Meaning	Basic	Exam.1	Exam.2
9		END			

After dialling **9** to programming tone the Ulydor will hang up.

#### 4.5 System Setting

Param.	Value	Meaning	Basic	Exam.1	Exam.2
6#	s	number of non-fitted buttons of basic module			

The basic module is fitted with 2 buttons as standard, i.e. s = 0, s = 1 is set up for the basic module with one button and s = 2 for module without buttons. This is a factory setting and no service can change this parameter.

**Note:** Upon connection to the line the value of this parameter is checked and if not satisfactory for any reason it is set to s = 0 (for a module fitted with 2 buttons).

## 4.6 List of Presetting Parameters

Param.	Basic	Exam. 1	Exam. 2
Relay 1 mode	lock m=1	lock m=1	lock m=1
Relay 2 mode	lock m=1	camera m=2	prog. m=5
Password Day+Night - Relay1	not	121	4561
Password Day+Night - Relay 2	not	122	4562
Password Day - Relay 1	not	not	not
Password Day - Relay 2	not	not	not
Password Night – Relay 1	not	not	not
Password Night – Relay 2	not	not	not
Relay 1 active from phone	55	55	55
Relay 2 active from phone	66	66	66
Closing time of switch 1 and 2	5 sec	2 sec	5 sec
Connection of incoming call	allowed	allowed	allowed
Delay between closing first and second relay	10 sec	10 sec	15 sec
Choice	DTMF	DTMF	DTMF
Sign of call extension	*	*	*
Hanging up from phone 1 / 2	55 / 66	55 / 44	55 / 44
Service password	0000	0000	0000
Switching to day mode	11	11	11
Switching to night mode	10	10	10
Ulydor choice mode	2 groups	Day/Night	2 groups
Keypad connection	no	no	on 1 <sup>st</sup> place
Keypad mode	dialing	Memory nos.	dialing
Number of rings of incoming call	2	1	2
Maximum call time	2 min	2 min	1 min
Time between button presses	2 sec	2 sec	2 sec
Time of hanging up when dialling repeated	2 sec	2 sec	2 sec
Time before dialling	1 sec	1 sec	1 sec
Number of rings before hanging up	12	12	12
DTMF tone duration (tone) choice	100ms	100ms	100ms
Gap duration among DTMF tones	100ms	100ms	100ms
Flash duration	100ms	100ms	100ms
Pause duration / interdigit gap	800ms	800ms	800ms

## 5 TECHNICAL PARAMETERS

### 5.1 Electrical Parameters

Param.	Value	Conditions
Minimum line current	18mA	line answered
Minimum line voltage	18V	line hang up
Voltage on line while Ulydor answers (VA characteristics)	< 8V < 12V	I = 20mA I = 60 mA
Leakage in hang up status	< 50uA	U = 60V
Impedance of line termination	130R + 820R paral. 220n	line answered
Band width	300Hz – 3400 Hz	20 - 60mA
Impedance of ringing	> 2Kohm	25 – 60 Hz
Sensitivity of ringing detector	min. 10 – 25 V	
Pulse choice	40 / 60 ms	
Tone choice level	4 a 6 dB	20 – 60 mA
Tone choice sensitivity	40 dB	20 – 60 mA
Sensitivity of tone detector	30 dB	20 – 60 mA
Power supply of lighting, switches and heating	12Vss ± 2V , 10-12Vst ± 2V	
Maximum consumption of lighting and heating	300mA	12Vss
Maximum voltage of switch contact	48V	at I < 1A
Maximum current of switch contact	2A	at U < 30 V
Operational temperature	- 20 to + 50 °C	

### 5.2 Mechanical dimensions

Type of Item	Dimensions HxWxD [mm]			
	1 Module	2 Modules	3 Modules	4 Modules
Surface Mount Box (SMBx)	151 x 157 x 79	241 x 157 x 79	331 x 157 x 79	421 x 157 x 79
Flush Mount Box (FMBB1)	114 x 118 x 45	204 x 118 x 45	294 x 118 x 45	384 x 118 x 45
Flush Mount Box (FMBB2)	-	204 x 286 x 45	294 x 286 45	384 x 286 x 45
EWHxx	149 x 151 x 49	241 x 151 x 49	331 x 151 x 49	421 x 151 x 49
Fixing Frame	147 x 151 x 3	239 x 151 x 3	299 x 151 x 3	399 x 151 x 3

## 6 TABLE OF EASY PROGRAMMING

Complete the section "**Your Values**" with the values to be programmed. In double-frame part there are whole programming commands, so the programming is very simple and without errors.





Meaning		Programming Sequence		No. Of point
Description	Spec.	Par.	Complete your values	
Number under button 1	Group 1 – Day	101		16
Number under button 2	Group 1 – Day	102		16
Number under button 3	Group 1 – Day	103		16
Number under button 4	Group 1 – Day	104		16
Number under button 5	Group 1 – Day	105		16
Number under button 6	Group 1 – Day	106		16
Number under button 7	Group 1 – Day	107		16
Number under button 8	Group 1 – Day	108		16
Number under button 9	Group 1 – Day	109		16
Number under button 10	Group 1 – Day	110		16
Number under button 11	Group 1 – Day	111		16
Number under button 12	Group 1 – Day	112		16
Number under button 1	Group 2 – Night	201		16
Number under button 2	Group 2 – Night	202		16
Number under button 3	Group 2 – Night	203		16
Number under button 4	Group 2 – Night	204		16
Number under button 5	Group 2 – Night	205		16
Number under button 6	Group 2 – Night	206		16
Number under button 7	Group 2 – Night	207		16
Number under button 8	Group 2 – Night	208		16
Number under button 9	Group 2 – Night	209		16
Number under button 10	Group 2 – Night	210		16
Number under button 11	Group 2 – Night	211		16
Number under button 12	Group 2 – Night	212		16
Relay 1 works in mode	m=1 – 4	311		1
Relay 2 works in mode	m=1 - 5	312		1
Password for Relay 1	Day+Night	321		6
Password for Relay 2	Day+Night	322		6
Password for Relay 1	Day	331		6



Meaning		Programming Sequence		No. Of point
Description	Spec.	Par.	Complete your values	
Password for Relay 2	Day	332		6
Password for Relay 1	Night	341		6
Password for Relay 2	Night	342		6
Closing of Relay 1 from phone		351		2
Closing of Relay 2 from phone		352		2
Closing time of Relay 1	[sec]	361		2
Closing time of Relay 2	[sec]	362		2
Relay 1 connected by incoming call	1 / 0	371		1
Relay 2 connected by incoming call	1 / 0	372		1
Time between Relays 1 & 2 closing	[sec]	38		2
Tone/pulse tone choice	1 / 0	41		1
Sign of call extension	* / #	42		1
Ulydor hanging up from phone	1.	431		2
Ulydor hanging up from phone	2.	432		2
Service password		44		4
Communication to <b>DAY</b> switching		45		2
Communication to <b>NIGHT</b> switching		46		2
Ulydor choice mode	1 / 0	47		1
Keypad connection	0 / 1 / 2	48		1
Keyboard mode	1 / 0	49		1
Number of rings		51		1
Maximum call duration	[min]	52		2
Time between button presses	[sec]	53		1
Hanging up time before dialling repeated	[sec]	54		1
Time before dialling starts	[sec]	55		1
Number of rings before system hangs up		56		2
Duration of dialling tone	(n+5)x10	57	ms	1
Gap among DTMF tones	(n+5)x10	58	ms	1
Recall duration	nx100	59	ms	1
Pause duration / interdigit gap	nx100	50	ms	1



## 7.2.2 Tones

Description of the tones (given in seconds)	Tone	Pause
<b>Dial tone</b> (continuous)		
<b>Special dial tone</b> (400/425 Hz, Dauerton)		
<b>Busy tone</b> (425 Hz, repeated)		
<b>Positive acknowledge tone</b> (single)		
<b>Negative acknowledge tone</b> (single)		

## 7.3 Programming

You can enter the programming mode 20 sec – 10min after power supply **ON** by **\*\*9** choice (to dial / busy tones) namely after Disty 300 power supply **ON**. If you had entered a new PIN in previous programming (par.2) so now you must enter a correct **PIN** for entry to programming (following main reset (par. 90) the PIN should not be entered). The special dialing tone is heard in programming mode. The entry and correct PIN are confirmed by confirmation tone, the false PIN by error tone.

Param.	Value	Meaning
<b>**9</b>	[xxxx]	entry to programming, xxxx=PIN, if entered
<b>0</b>	#	log off – stored DECT parameters will be deleted
<b>1</b>	xxxxxxx #	entry code to base station (4-8 numbers)
<b>2</b>	xxxx yyyy #	PIN change - xxxx is old, yyyy is new, <b>0000</b> is firm one
<b>3</b>	0# - 79#	distance – number load is multiple of 130m (300m = 3)
<b>40</b>	<b>0</b> # / 1#	choice mode - <b>0</b> sends / 1 suppresses DTMF choice transmission from base station ( <b>0</b> is pract. doubled choice)
<b>41</b>	<b>0</b> # / 1#	operational setting - <b>0</b> is phone / 1 is FAX
<b>70</b>	<b>0</b> # / 1# / 2#	call limitation - <b>0</b> not limited, 1 incoming, 2 outcoming
<b>71</b>	0# / 1# / 2#	type of call - 0 both, 1 internal, 2 external call
<b>72</b>	xxx #	Flash length – xxx times 10ms (100ms = 010) firm.= <b>210ms</b>
<b>90</b>	#	reset and company setting (bold), presets all
<b>91</b>	#	reset and company setting (bold), log in parameters will be kept
<b>92</b>	<b>0</b> # / 1#	autoreset <b>0</b> -inactive / 1-active (every 24 hrs will end all transmissions and recall to base station)

Settings for use with Ulydor: (90#), 401#, 410#, 700#, 710#

**Internal call** will be executed by **\*\*s**, where **s** is 0-9 i.e. number of internal station, station 9 may be called 10min after power supply ON, up to this moment it is entry to programming.

**Note:** The switching of call/internal query can be made by “Flash” and **\*\*s** choices. The call will be switched over by hanging up. The “Flash” function will turn back to previous call.

## **7.4 Log on to Base Station**

The log in might be done automatically in this way that we hold the button for searching on base station (min 3sec) and then we will connect the power supply to DistyBox. This will automatically log on to base station within 1 min and if not made it is recommended to make the company reset (90#) and repeat logging on. Setting of parameters 401#, 410#, 700#, 710# is required.

**Be sure** about parameter 40, which is being set after company reset thus that the choice is transmitted not only by DES, but also the base station so that the choice is executed twice!!

## 8 IP CAMERA

---



**IP Camera**

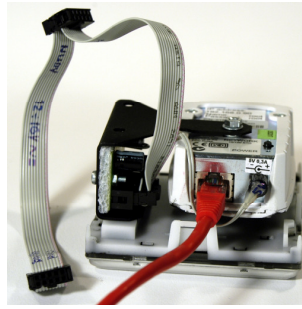

**Rear View of IP Camera**

The IP Camera is quick and straight-forward to install via your structured cable network by adopting the RJ45-RJ45 lead (red lead on the Rear View photograph) between camera and the wall socket. Programme the camera via the web, logging its IP address and serial number. Once accepted file the information under "favourites" on your web browser (or create a shortcut on your desktop). When receiving a call from the Ulydor reception unit, simply go into "favourites" (or the shortcut) and by depressing the appropriate flag your computer screen will 'pop' displaying the image of the visitor and a conversation can take place.